

# Design of a Fire Location Monitoring System Using Temperature and Smoke Detectors on Sea Ships

Indrawati Apriliyah<sup>1,a)</sup>, Riries R.<sup>1</sup>, and Winarno<sup>1</sup>

<sup>1</sup>Department of Physics, Faculty of Science and Technology, Universitas Airlangga Surabaya, East Java, Indonesia

<sup>a)</sup> email : liapriyah@gmail.com

**Abstract.** A fire location monitoring system is designed in this study to determine the location of a fire on a ship. The inputs used are temperature detectors and smoke detectors. The fire location monitoring system is designed using raspberry pi as a mini pc, temperature detector, smoke detector, alarm and Lazarus as a user interface. The room used as the object of research consists of the control room, steering room, engine room and kitchen room. The type and number of detectors used vary depending on the design of the detector placement in each room. Based on the tests that have been carried out, the fire location monitoring system is able to detect a fire when the temperature or smoke detector is active. In addition, the system is able to show the location of detectors that actively detect fires accompanied by an alarm sound. The average performance of the system in detecting a fire is 93%.

## INTRODUCTION

In Indonesia, one of the sea transportation tools used is the ship. Ships are used by the people of Indonesia to carry out various activities, such as the process of shipping fuel oil between islands, distributing large quantities of goods from companies to distributors on other islands, and so on.

Meanwhile, lately there have been many problems on ships. One of these problems is ship fires. As in August 2016, a motorboat-type ship caught fire in the waters of the Strait of Buton, Southeast Sulawesi and caused 6 deaths and 14 survivors (Pati, 2016). This is supported by the National Transportation Safety Committee (KNKT) in the report on Accident Data Analysis and Investigation of Sea Transportation in 2007-2011 which states that the most common type of accident on ships is burning or exploding ships.

Currently, the solution to this problem is to use a fire detection system. However, the error ratio of such systems is still large because the information provided at the time of detecting a fire is only in the form of sound or light on the panel. In addition, the existing fire detection system only shows the zone where the fire occurred, even though one zone can consist of several rooms. This makes various parties unable to know the location of the fire.

Therefore, there is a need for a device that can show the location of a fire but at a lower price than the current fire detection system. In addition, using an interface device is expected to indicate the presence of a fire along with the location of the fire on the ship through a detector that is active when a fire occurs. The detector will be used as an input that functions to detect the presence of smoke and temperature changes in a room.

## THEORETICAL FOUNDATION

### Fire Detection System

A fire detection system or also known as a fire alarm system is a system designed to be able to determine the position of the fire point and provide warnings to all occupants of a building (Rosseno, 2011). Fire detection systems are divided into 2 types, namely conventional and addressable.

Conventional fire detection systems use the principle of direct connection between individual sensors or a collection of several sensors in one zone with extinguisher indicator. The circuit is made from a collection of several sensors installed in parallel and connected to the control system.

Addressable fire detection systems are the most advanced and most accurate type of system for pinpointing fires. This is because each sensor has its own address and is connected to a data line. So it is more detailed to know the position of the sensor that is currently active. The disadvantage of this system is that the price of this system is much more expensive than conventional fire detection systems due to each point having its own address.

## Temperature Detector

Temperature detector is a device that works because of the rapid increase in temperature in a room (Patigeni1, 2015). Temperature detectors are divided into two types, namely rate of rise (ROR) and fixed temperature. Rate of rise type detectors will be active when there is a temperature increase of 120 C to 150 C (Patigeni2, 2015). While the fixed temperature detector is a detector that will be active when the temperature in the room exceeds the detector set point temperature with the set point temperature used is 600 C (Bromindo, 2014). Both types of detectors use bimetal to detect changes in temperature in a room. Bimetal consists of two materials with different coefficients of expansion. The working principle of bimetal is stated in Figure 1.

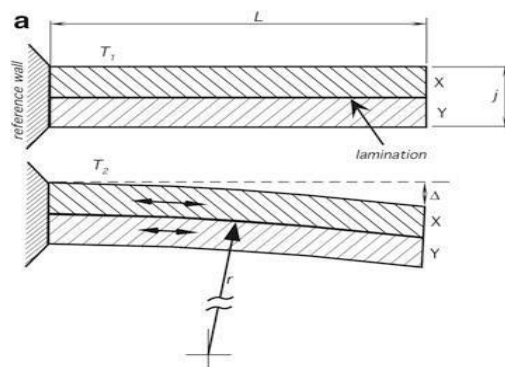

FIGURE 1. Working principle of bimetal (Source: Fraden, 2016)

## Smoke Detector

Smoke detectors are detectors that detect the presence of air particles in small sizes. Smoke detectors are divided into two types based on their working principle, namely ionization and optical detectors (Fraden, 2016).

Optical smoke detectors use light to detect smoke. This type of smoke detector uses a light source and detector placed in a room. The detector used is a photosensor.

Under normal conditions, when there is no smoke entering the chamber, the light emitted by the source will move straight through the smoke chamber so that the current generated by the light detector is small. However, when smoke enters the chamber and blocks the path that light passes through, the light will spread in all directions. Small particles will experience Rayleigh scattering, while larger particles will experience specular reflection in all directions including to the smoke chamber.

Direction of the detector channel. In the detector channel, there is glass on the opposite side of the detector. This serves to reflect the scattered light towards the detector so as to increase the sensitivity of the detector. Large particles cause the current generated by the detector to get bigger. Next, the detector will be connected to a light to voltage converter which will then set the threshold value for the detector to detect smoke. If the voltage generated exceeds the specified value, an alarm will sound as information of a fire.

The working principle of the ionization type smoke detector is expressed in Figure 2.

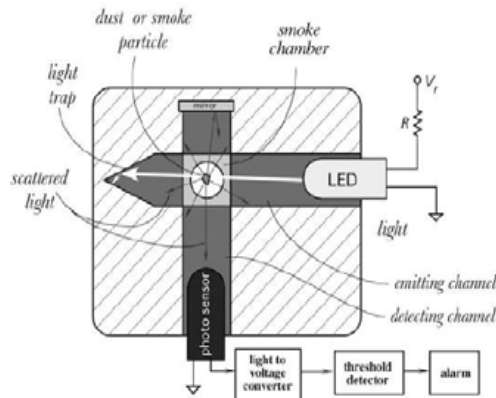

FIGURE 2. Working principle of optical type smoke detector (Source: Fraden, 2016)

## RESEARCH METHODS

This research was conducted in Electronics Laboratory, Department of Physics, Faculty of Science and Technology, Universitas Airlangga, Campus C Mulyorejo Surabaya. This research was conducted for 5 months from April 2017 to August 2017.

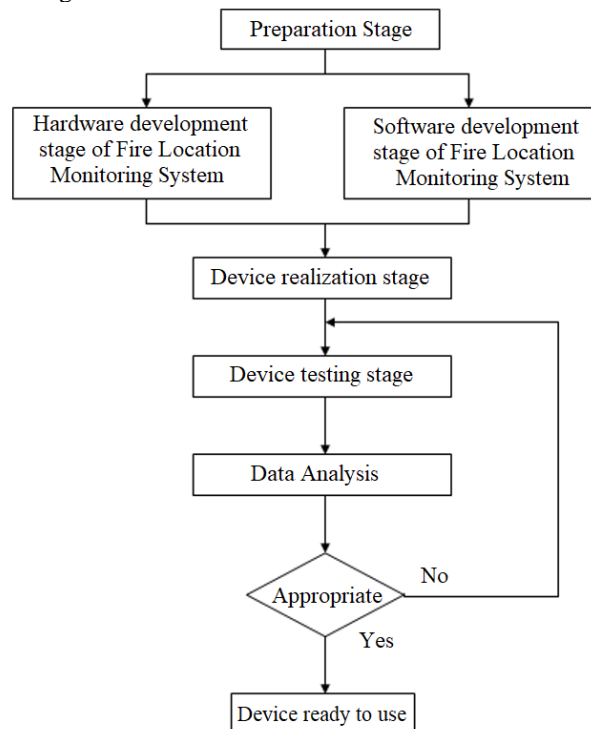

FIGURE 3. Block diagram of the research procedure

### Preparation Stage

At this stage, the necessary materials and equipment are collected. In addition, settings are made on the raspberry pi and preparation for using the raspberry pi using Lazarus software

### Stage Manufacture Hardware Fire Site Monitoring System

The fire location monitoring system that will be used to detect fires consists of a temperature detector, smoke detector, MY2N relay, raspberry pi 2 model B, fire alarm, led light and monitor. The block diagram of the fire location monitoring system is shown in Figure 4.

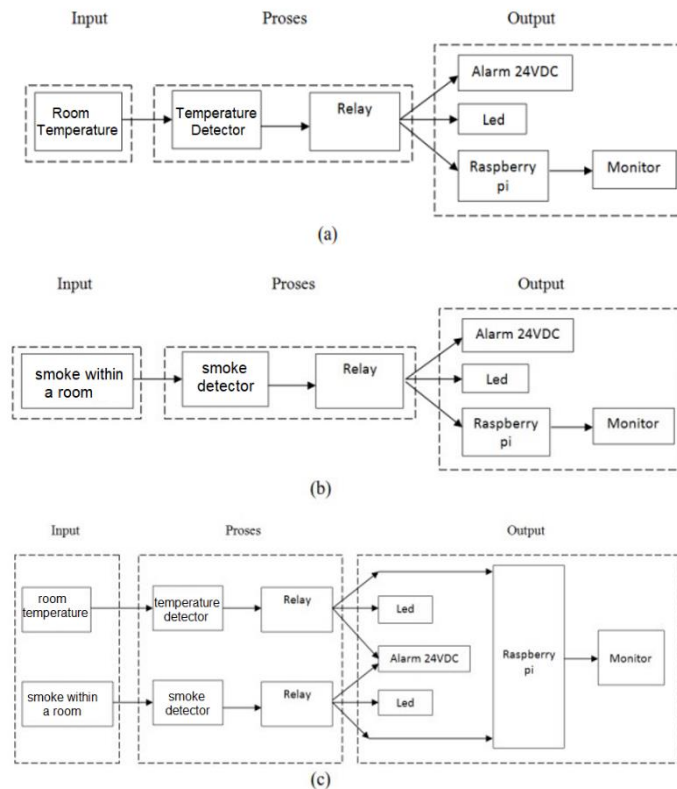

**FIGURE 4.** Block diagram of fire location monitoring system with input: (a)Temperature detector, (b)Smoke detector and (c)Temperature detector and smoke detector

### Stage Creation Software Fire Site Monitoring System

At this stage, the design of the fire location monitoring system software display is carried out. The stages of making software consist of 10 stages, namely detector placement design, making the main menu, making the instructions for use menu, making the control room monitoring menu, making the steering room monitoring menu, making the engine room monitoring menu, making the kitchen room monitoring menu, making the entire room monitoring menu, fire location monitoring system flowchart and fire location monitoring system flowchart.

### Tool Realization Stage

In the tool realization stage, there is a setup process on a raspberry pi integrated with a temperature and smoke detector that is able to provide information about the presence of fire in a room and displayed on a monitor. Next, combining hardware and software to produce a fire location monitoring system based on temperature and smoke detector inputs..

### System Testing Phase

At this stage, testing of the device using a candle as a heat source in detecting temperature changes by a temperature detector and mosquito coils as a smoke source by a smoke detector is carried out. In addition, system testing is carried out using a monitor as visual fire information for each room tested.

## RESULTS AND DISCUSSION

### Results Creation Hardware Fire Site Monitoring System

The results of making the fire location monitoring system hardware are divided into two, namely hardware that functions as a fire location monitoring system panel (Figure 5) and hardware that functions as a 24VDC voltage source panel for temperature detectors, smoke detectors and alarms (Figure 6).

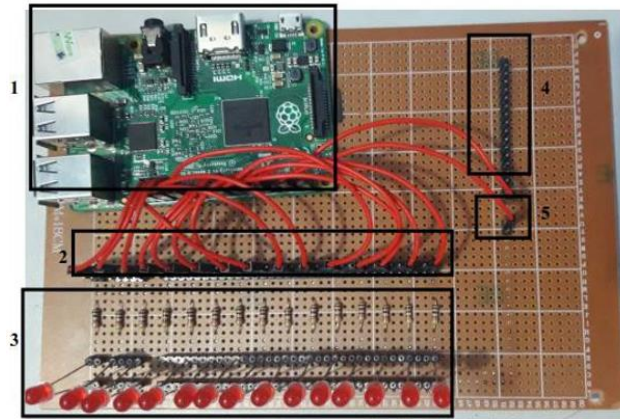

FIGURE 5. PCB panel sistem monitoring lokasi kebakaran

Based on Figure 5, number one shows the working raspberry pi as a mini pc to display fire information on the monitor. Number two, used as a pin that connects between the relay and raspberry pi as a detector data output. In addition, the resulting output is in the form of an LED flame connected to pin number 2. Number three shows the led connected to a  $1k\Omega$  resistor. Number four is used to connect 5V raspberry pi Vcc on pin 2 to the relay COM pin. Number five is a ground pin that is used to connect led ground and raspberry pi ground on pin 6. The number of detectors that can be used on this panel is 15 detectors.

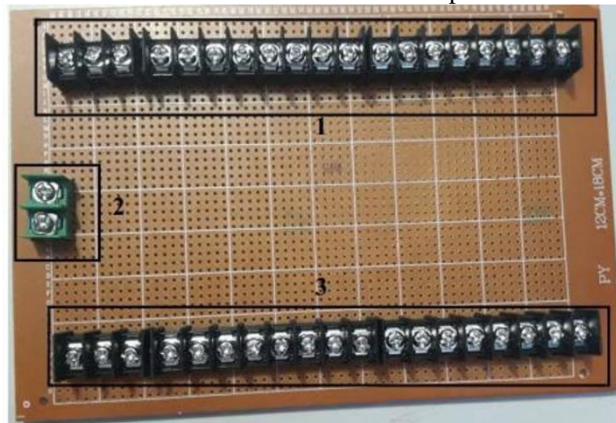

FIGURE 6. 24VDC voltage source panel PCB

Based on Figure 6, number one is a ground pin connected to the ground detector and alarm. While number two is Vcc and ground 24VDC voltage source. Number 3 is the Vcc pin of the voltage source connected to the Vcc of the detector and alarm. Between the ground pin of the 24VDC voltage source and pin number one there is a switch that functions as a reset button for the fire location monitoring system.

### Software Development Results of Fire Location Monitoring System

The fire location monitoring system is made using Lazarus which is inserted into the raspberry pi as a mini pc. The display from the raspberry pi is displayed by the monitor. The fire location monitoring system is used to visually show the location of the fire. Before the system is run, the detector must be off. So, when the system is opened, confirmation questions and notifications appear so that the system runs properly. The main menu of the system is shown in Figure 7.



**FIGURE 7.** Main menu display of the system On the main menu, there are several

The menus that can be selected are: instructions for use, monitoring all rooms, monitoring the control room, monitoring the steering room, monitoring the engine room, monitoring the kitchen and exiting. The user manual menu contains how to use the system along with examples. The instructions for using the system must be read carefully so that no errors occur when the system is run or the information displayed. The whole room monitoring menu contains monitoring of four rooms that are used as research objects. This menu is used to monitor all four rooms at once. Each room can be enlarged by clicking once on the room image or room name.

The display of the all-room monitoring menu is shown in Figure 8.

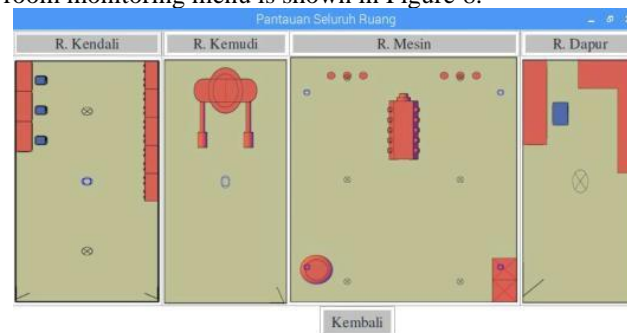

**FIGURE 8.** Display of all room monitoring menu

The control room monitoring menu, steering room monitoring, engine room monitoring and kitchen monitoring menu only display one room. In addition, there is information on the date, time and status change of the detector. So that users can find out the time of the fire through information on changes in detector status. The exit button is used to exit the system.

### System Test Results Using Temperature Detectors

This test is conducted to determine the response of the monitoring system in detecting a fire through the temperature detector input. If the detector is active, the detector activates the relay. Then, the relay activates the alarm, turns on the led and sends a signal to the raspberry pi via the GPIO pin. Inside the raspberry pi there is a comparator connected to the GPIO pin. The function of the comparator is to compare the detector's analog voltage signal that enters the GPIO pin with the threshold voltage value in the comparator, so that the signal changes to an on- off voltage level can be processed by Raspberry Pi into logic high or low. When the detector is active, the system processes the signal into a logic high and displays information on the presence of a fire. Meanwhile, when the detector is not active, the relay is not active. Thus, the alarm is not active, the led does not light up and the signal sent to the raspberry pi is read as logic low. This causes the system to display information that there is no fire.

**TABLE 1.** Temperature detector test results

No.	Thermometer Measured Temperature ( <sup>0</sup> C)	Detector Status
1	60,1	Active
2	30,8	Inactive
3	64,1	Active
4	60,4	Active
5	53,5	Inactive
6	36,2	Inactive
7	64,0	Active
8	30,4	Inactive
9	34,4	Inactive
10	66,0	Active
11	38,8	Inactive
12	64,5	Active
13	65,3	Active
14	30,7	Inactive
15	62,4	Active
16	32,7	Inactive
17	36,2	Inactive
18	30,1	Inactive
19	64,1	Active
20	68,4	Active

**TABLE 2.** Test results of the temperature detector in the control room

No.	Measured Temperature Thermometer ( <sup>0</sup> C)	Detector Status	Status Alarm	Led Status	Status Info on the System	Performance System
1	30,8	Temperatur detector 1 inactive	Inactive	Off	None fire	As per
2	62,4	Temperature detector 1 active	Active	On	There is fire	As per
3	40,4	Temperature detector 1 inactive	Inactive	Off	None fire	As per
4	34,4	Temperature detector 1 inactive	Inactive	Off	None fire	As per
5	30,1	Temperature detector 2 inactive	Inactive	Off	None fire	As per

**TABLE 3.** Test results of the temperature detector in the kitchen room

No.	Measured Temperature Thermometer ( $^{\circ}\text{C}$ )	Detector Status	Status Alarm	Led Status	Status Info on the System	Performance System
1	30,4	Inactive	Inactive	Off	None fire	As per
2	62,1	Active	Active	On	There was a fire	As per
3	33,1	Inactive	Inactive	Off	None fire	As per
4	30,8	Inactive	Inactive	Off	None fire	As per

**TABLE 4.** Test results of the temperature detector in the engine room

No.	Measured Temperature Thermometer ( $^{\circ}\text{C}$ )	Detector Status	Status Alarm	Led Status	Status Info on the System	Performance System
1	53,5	Temperature detector 1 inactive	Inactive	Off	None fire	As per
2	60,4	Temperature detector 1 active	Active	On	There was a fire	As per
3	38,1	Temperature detector 1 inactive	Inactive	Off	None fire	As per
4	63,9	Temperature detector 1 active	Active	On	There was a fire	As per
5	38,0	Temperature detector 1 inactive	Inactive	Off	No fire	As per

Based on the data in Table 1, it is obtained that the temperature detector is active when the temperature exceeds 600 C. Furthermore, the push button is changed to the off position to turn off the detector. The time it takes for the temperature detector to change position from on to off is about 183 seconds. After that, the temperature detector automatically deactivates and the system changes to the no fire information. In addition, the detector works normally with a led indicator that lights up once every 4 to 6 seconds. In testing the system using temperature detectors, three rooms are used as research objects, namely the control room, kitchen room and engine room. The temperature detector test data in the control room is contained in Table 2. Temperature detector test data in the kitchen is in Table 2. The temperature detector test data in the engine room is contained in Table 4. Information on the presence of a fire displayed by the system in the form of a notification accompanied by a room that detected a fire. A red circle indicates that the temperature detector is active. Information on the presence of fire displayed by the fire location monitoring system is shown in Figure 9.



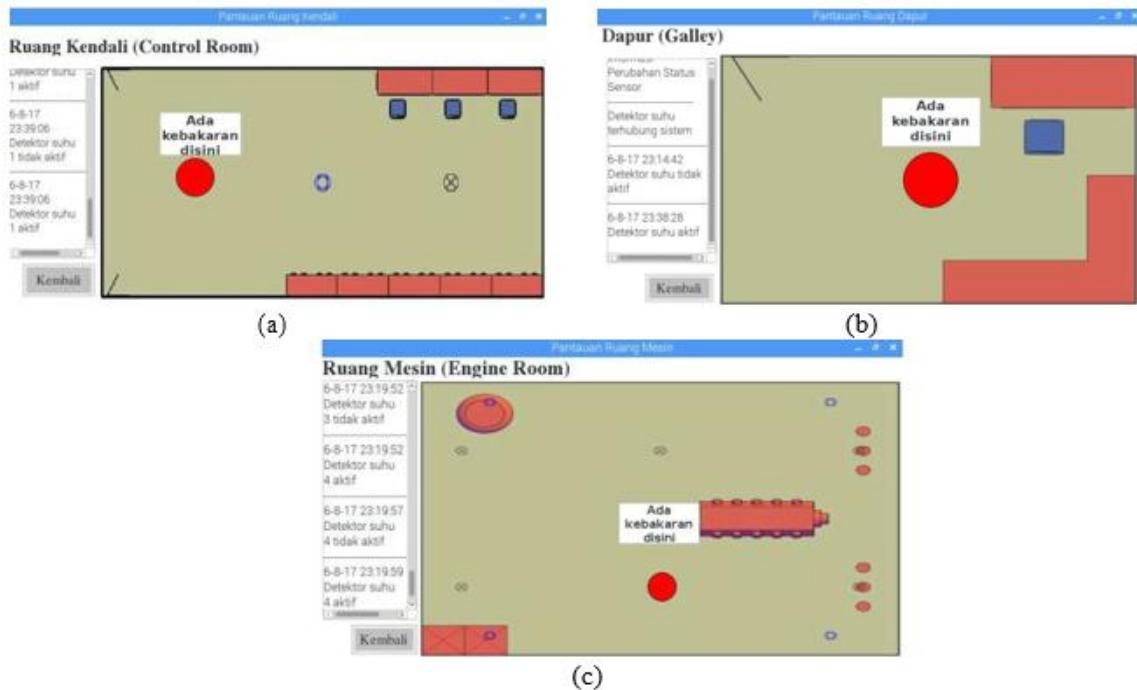

**FIGURE 9.** Information displayed by the fire location monitoring system when the temperature detector is active in: (a) Control room, (b) Kitchen room and (c) Engine room.

In the fire location monitoring system, there is a weakness in displaying fire information. The weakness in question is that the system does not display information on the presence of a fire as long as the mouse is not moved. In addition, the date and time information on changes in detector status is not necessarily the same as the date and time in actual conditions. From the tests that have been carried out, the performance of the fire location monitoring system is 100%. This is because the indicators of the success of the performance of the fire location monitoring system have been met.

### System Test Results Using Smoke Detectors

This test is conducted to determine the response of the monitoring system in detecting a fire through the smoke detector input. If the detector is active, the detector activates the relay. Then, the relay activates the alarm, turns on the led and sends a signal to the raspberry pi via the GPIO pin. Inside the raspberry pi there is a comparator connected to the GPIO pin. The function of the comparator is to compare the detector analog voltage signal that enters the GPIO pin with the threshold voltage value in the comparator, so that the signal changes to an on-off voltage level that can be processed by Raspberry Pi into high or low logic. When the detector is active, the system processes the signal obtained into logic high and displays information on the presence of a fire. Meanwhile, when the detector is not active, the relay is not active. Thus, the alarm is not active, the led does not light up and the signal sent to the raspberry pi is read as logic low. This causes the system to display information that there is no fire.

**TABLE 5.** Smoke detector test results in the control room

No	There is Smoke	Detector Status	Alarm Status	Led Status	Status Info on System	System Performance
1	None	Inactive	Inactive	Off	No fire	As per
2	Yes	Active	Active	On	There was a fire	As per
3	Yes	Active	Active	On	There was a fire	As per
4	Yes	Active	Active	On	There was a fire	As per
5	None	Inactive	Inactive	Off	No fire	As per
6	Yes	Inactive	Inactive	Off	No fire	Not suitable

**TABLE 6.** Test results for smoke detectors in the wheelhouse

No	There is Smoke	Detector Status	Alarm Status	Led Status	Status Info on System	System Performance
1	None	Inactive	Inactive	Off	No fire	As per
2	Yes	Inactive	Inactive	Off	No fire	Not suitable
3	Yes	Active	Active	On	There was a fire	As per
4	None	Inactive	Inactive	Off	No fire	As per
5	Yes	Inactive	Inactive	Off	No fire	Not suitable
6	Yes	Active	Active	On	There was a fire	As per

**TABLE 7.** Smoke detector test results in the engine room

No	There is Smoke	Detector Status	Alarm Status	Led Status	Status Info on System	System Performance
1	None	Inactive	Inactive	Off	No fire	As per
2	Yes	Smoke detector 1 active	Active	On	There was a fire	As per
3	Yes	Smoke detector 1 active	Active	On	There was a fire	As per
4	Yes	Smoke detector 2 active	Active	On	There was a fire	As per
5	None	Smoke detector 2 inactive	Inactive	Off	No fire	As per
6	Yes	Smoke detector 3 inactive	Inactive	Off	No fire	Not suitable

In testing the system using smoke detectors, three rooms are used as research objects, namely the control room, steering room and engine room. Smoke detector test data in the control room is contained in Table 4.5. Smoke detector test data in the steering room is contained in Table 5. The test data for smoke detectors in the engine room is contained in Table 7. Information on the presence of a fire displayed by the system in the form of a notification along with the room where the fire was detected. A blue circle indicates that the smoke detector is active. The fire information displayed by the fire location monitoring system is shown in Figure 10.

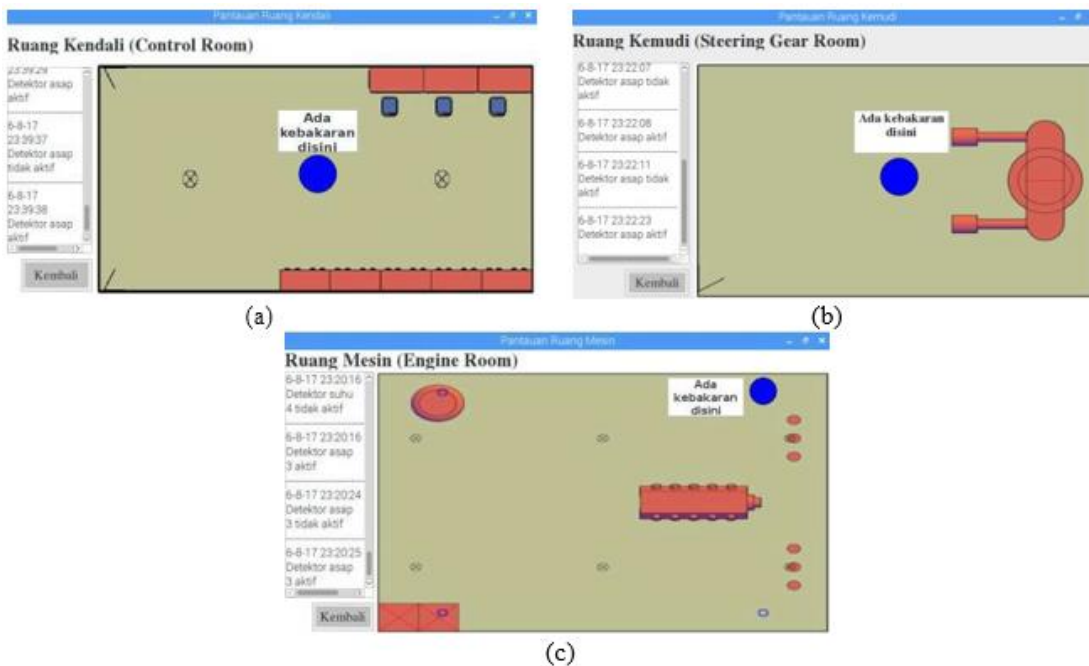

**FIGURE 10.** Information displayed by the fire location monitoring system when the smoke detector is active in: (a) Control room, (b) Steering room and (c) Engine room.

In the fire location monitoring system, there is a weakness in displaying fire information. The weakness in question is that the system does not display information on the presence of a fire as long as the mouse is not moved. In addition, the date and time information on changes in detector status is not necessarily the same as the date and time in actual conditions. From the tests that have been carried out, the performance of the fire location monitoring system is 82%. This is because the indicators of the success of the performance of the fire location monitoring system have not been fully met. One of the unmet success indicators is that the smoke detector is not active when there is smoke in a room.

**System Test Results Using Temperature and Smoke Detectors**

This test is conducted to determine the response of the monitoring system in detecting a fire through the input of temperature and smoke detectors. If the detector is active, the detector activates the relay. Then, the relay activates the alarm, turns on the led and sends a signal to the raspberry pi via the GPIO pin.

Inside the raspberry pi there is a comparator connected to the GPIO pin. The function of the comparator is to compare the detector analog voltage signal that enters the GPIO pin with the threshold voltage value in the comparator, so that the signal changes to an on-off voltage level that can be processed by Raspberry Pi into high or low logic. When the detector is active, the system processes the signal obtained into logic high and displays information on the presence of a fire. Meanwhile, when the detector is not active, the relay is not active. Thus, the alarm is not active, the led does not light up and the signal sent to the raspberry pi is read as logic low. This causes the system to display information that there is no fire.

**TABLE 8.** Test results of temperature and smoke detectors in the control room

Temperature Detector				Smoke Detector				Alarm Status	System Performance
Measured Temperature Thermometer	Detector Status	Led Status	Status Info on System	There is Smoke	Detector Status	Led Status	Status Info on System		
30,8	Temperature detector 1 inactive	Off	No fire	There is	On	On	There was a fire	On	As per
62,4	Temperature detector 1 active	On	There was a fire	There is	On	On	There was a fire	On	As per
40,4	Temperature detector 1 inactive	Off	No fire	There is	On	On	There was a fire	On	As per
34,4	Temperature detector 1 inactive	Off	No fire	None	Off	Off	No fire	Off	As per
30,1	Temperature detector 2 inactive	Off	No fire	There is	On	On	There was a fire	On	As per

**TABLE 9.** Test results of temperature and smoke detectors in the engine room

Temperature Detector				Smoke Detector				Alarm Status	System Performance
Measured Temperature Thermometer	Detector Status	Led Status	Status Info on System	There is Smoke	Detector Status	Led Status	Status Info on System		
30,7	Temperature detector 1 inactive	Off	No fire	None	Smoke detector 1 inactive	Off	No fire	Off	As per
30,1	Temperature detector 1 inactive	Off	None fire	There is	Detector smoke 1 active	On	There was a fire	On	As per
38,8	Temperature detector 1 inactive	Off	None fire	There is	Detector smoke 1 active	On	There was a fire	On	As per

60,4	Temperature detector 1 active	On	There was a fire	None	Smoke detector 1 inactive	Off	No fire	On	As per
38,1	Temperature detector 1 inactive	Off	No fire	None	Smoke detector 1 inactive	Off	No fire	Off	As per

The difference between this system test and the two previous tests is the cable used to connect the relay to the alarm. In system tests using only temperature detectors or smoke detectors, the alarm is directly connected to the detector through a relay. Whereas in system tests using temperature and smoke detectors, the cables connecting the alarms for temperature and smoke detectors are connected. Thus, only one alarm is used. As a result, both tests when only the temperature detector is active or only the smoke detector is active or both.

When the detector is active, the alarm still turns on properly without affecting the fire information in the system. This shows that in one room, several detectors can be used as input and only one alarm as output information on the presence of a fire. In testing the system using temperature and smoke detectors, two rooms were used as research objects, namely the control room and the engine room. The temperature and smoke detector test data in the control room is contained in Table 8. The temperature and smoke detector test data in the engine room is in Table 9. Information on the presence of a fire displayed by the system in the form of a notification accompanied by a room that detected a fire. The red circle indicates that the temperature detector is active, while the blue circle indicates that the smoke detector is active. The fire information displayed by the fire location monitoring system is shown in Figure 11.

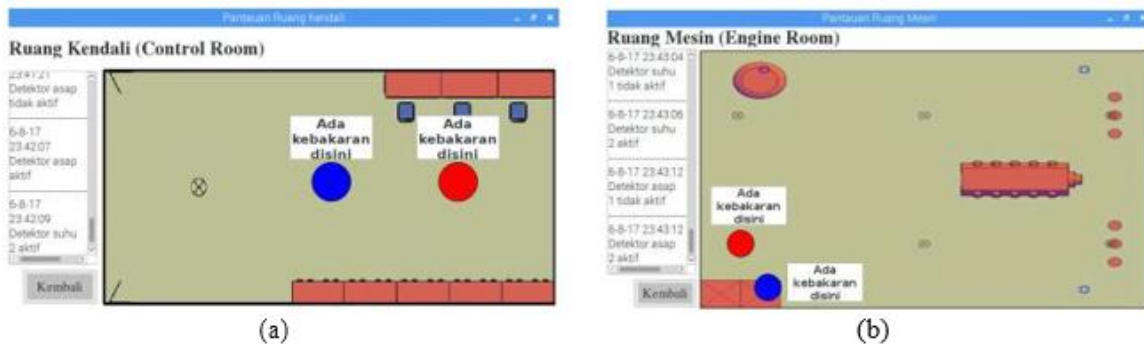

**FIGURE 11.** Information displayed by the fire location monitoring system when the temperature and smoke detectors are active in: (a) Control room, and (b) Engine room.

In the fire location monitoring system, there is a weakness in displaying fire information. The weakness in question is that the system does not display information on the presence of a fire as long as the mouse is not moved. In addition, the date and time information on changes in detector status is not necessarily the same as the date and time in actual conditions. From the tests that have been carried out, the performance of the fire location monitoring system is 96%. This is because the indicators of the success of the performance of the fire location monitoring system have not been fully met. One of the unmet success indicators is that the smoke detector is not active when there is smoke in a room.

From the three tests of the fire location monitoring system, the average system performance was 93%. This result is obtained from the summation of 80 test repetitions with details of 29 times in testing the system using temperature detector input, 23 times in testing the system using smoke detector input and 28 times in testing the system using temperature and smoke detector input. There is an error in the tests that have been carried out, due to the smoke detector not being active even though there is smoke in the room.

## CONCLUSION

1. The fire location monitoring system on ships is made using temperature and smoke detectors as inputs which are then processed by the raspberry pi via the GPIO pin. The detector analog voltage signal is converted into an on-off voltage level with a comparator on the GPIO pin, so that the raspberry pi can recognize the active detector when a fire occurs and display it to the monitor using Lazarus as a user interface.
2. The system's performance in detecting temperature- and smoke-based fires averaged 93%.

## REFERENCES

1. Ada, L., 2015, Introducing the Raspberry Pi 2 - Model B, 18 Juli 2017, <https://cdnlearn.adafruit.com/downloads/pdf/introducing-the-raspberry-pi-2-model-b.pdf>
2. Adafruit, 2016, Raspberry Pi 2, Model B, 18 Juli 2017, <https://cdn-shop.adafruit.com/pdfs/raspberrypi2modelb.pdf>
3. Andanniyo, G., Aryawan W.D., 2014, Desain Ulang Kapal Perintis 200 DWT Untuk Meningkatkan Performa Kapal, Institut Teknologi Sepuluh Nopember, Surabaya
4. Anonim, 2008, 2.7V 4-Channel/8-Channel 10-Bit A/D Converters with SPI Serial Interface, 14 Desember 2016, <https://www.adafruit.com/datasheets/MCP3008.pdf>
5. Anonim, 2014, How to Work with SSH Connections (SSH Clients), 2 Januari 2017, [http://www.tweaking4all.com/network-internet/sshclients/#ssh\\_client\\_windows](http://www.tweaking4all.com/network-internet/sshclients/#ssh_client_windows)
6. Anonim, 2015, How to Install Lazarus Pascal on Raspberry Pi 2 (Raspbian), 2 Januari 2017, <http://www.tweaking4all.com/hardware/raspberry-pi/install-lazarus-pascal-on-raspberry-pi-2/#tweakraspbian>
7. Anonim, 2015, Pengertian Sensor Suhu dan Jenis-Jenisnya, 10 Desember 2016, <http://teknikelektronika.com/pengertian-sensor-suhu-jenis-jenis-sensor-suhu/>
8. Anonim, 2016, Raspberry Pi 3 Model B, 11 Desember 2016, <http://www.rscomponents.com/raspberrypi>
9. Bromindo, 2014, Hong Chang Fixed Temperature Heat Detector HC-407A, 30 Desember 2016, <http://www.bromindo.com/portfolio/hong-chang-fixed-temperature-heat-detector-hc-407a/>
10. Chang1, H., 2005, HC-407A, 31 Desember 2016, <http://www.hc-fire-alarm.com/407a-e.htm>
11. Chang2, H., 2008, Smoke Detector, HC-206E, Optical (Photoelectric) Smoke Detector, 24 April 2017, <http://www.hong-chang.com.tw/s/2/product-176820/OpticalPhotoelectric-Smoke-Detector-HC-206E.html>
12. Favian, D., dan Supomo H., 2012, Perancangan Sistem Deteksi Kebakaran Berbasis Komputer Untuk Galangan Kapal, JURNAL TEKNIK ITS, Volume 1, No.1, Institut Teknologi Sepuluh Nopember, Surabaya
13. Fraden, J., 2016, Handbook of Modern Sensor Physics, Designs and Applications Fifth Edition, Springer, San Diego